

**PEURANKELLO A típus**  
 Földszinti alaprajz  
 Alapterület: ~81,0m<sup>2</sup> + terasz ~40m<sup>2</sup>

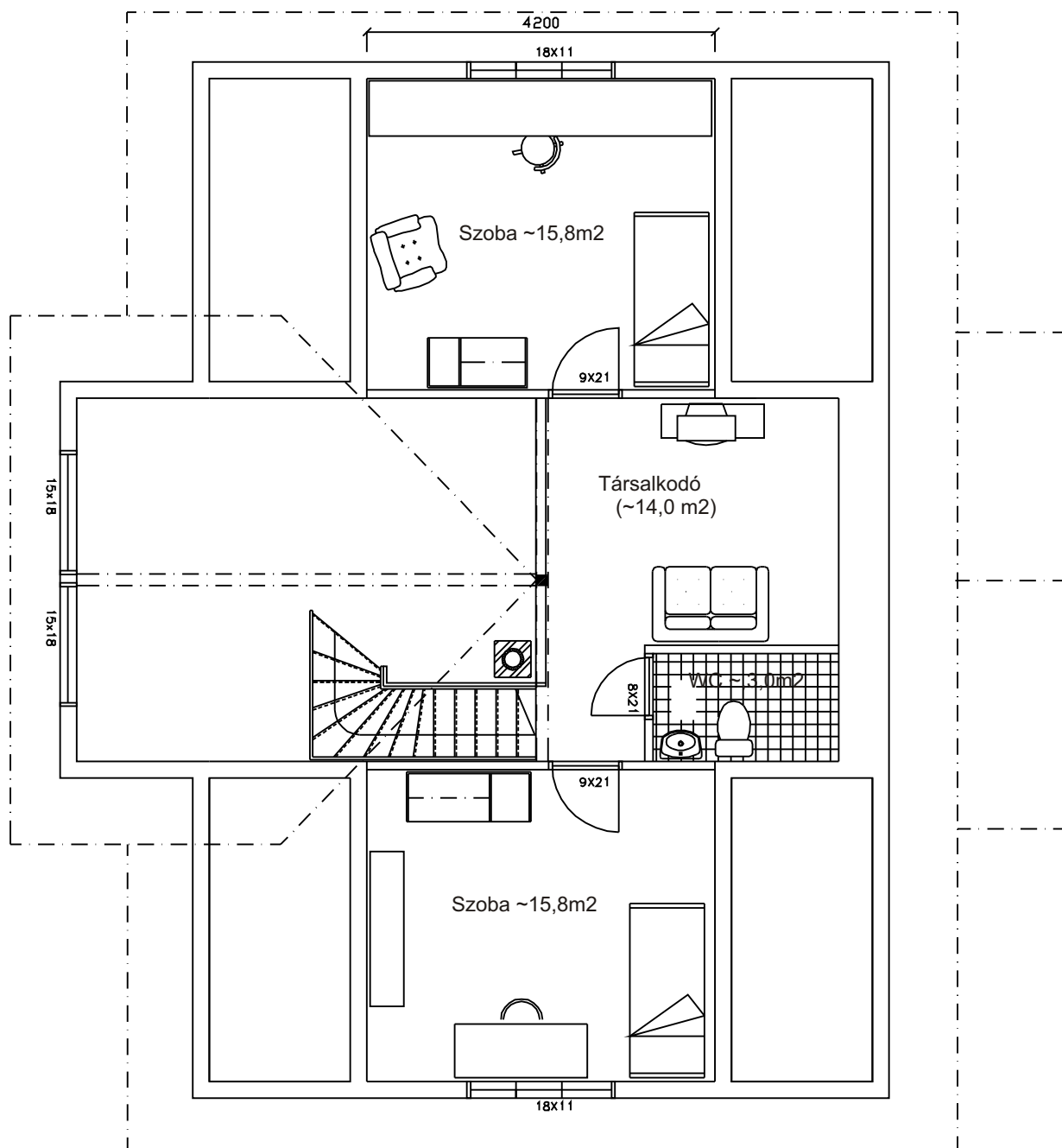

**PEURANKELLO A típus**  
 Tetőtéri alaprajz  
 Hasznos alapterület ~32,0m<sup>2</sup>

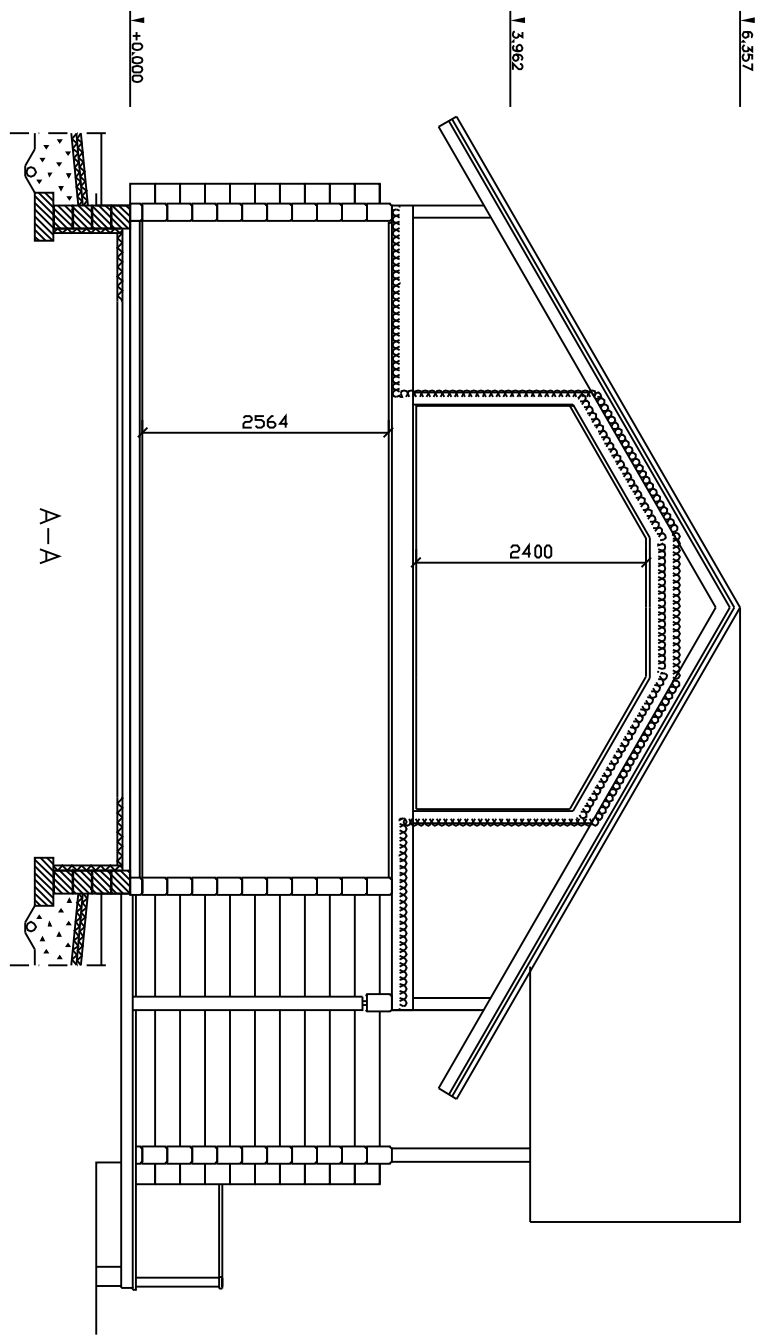

**PEURANKELLO A típus**  
A-A metszet

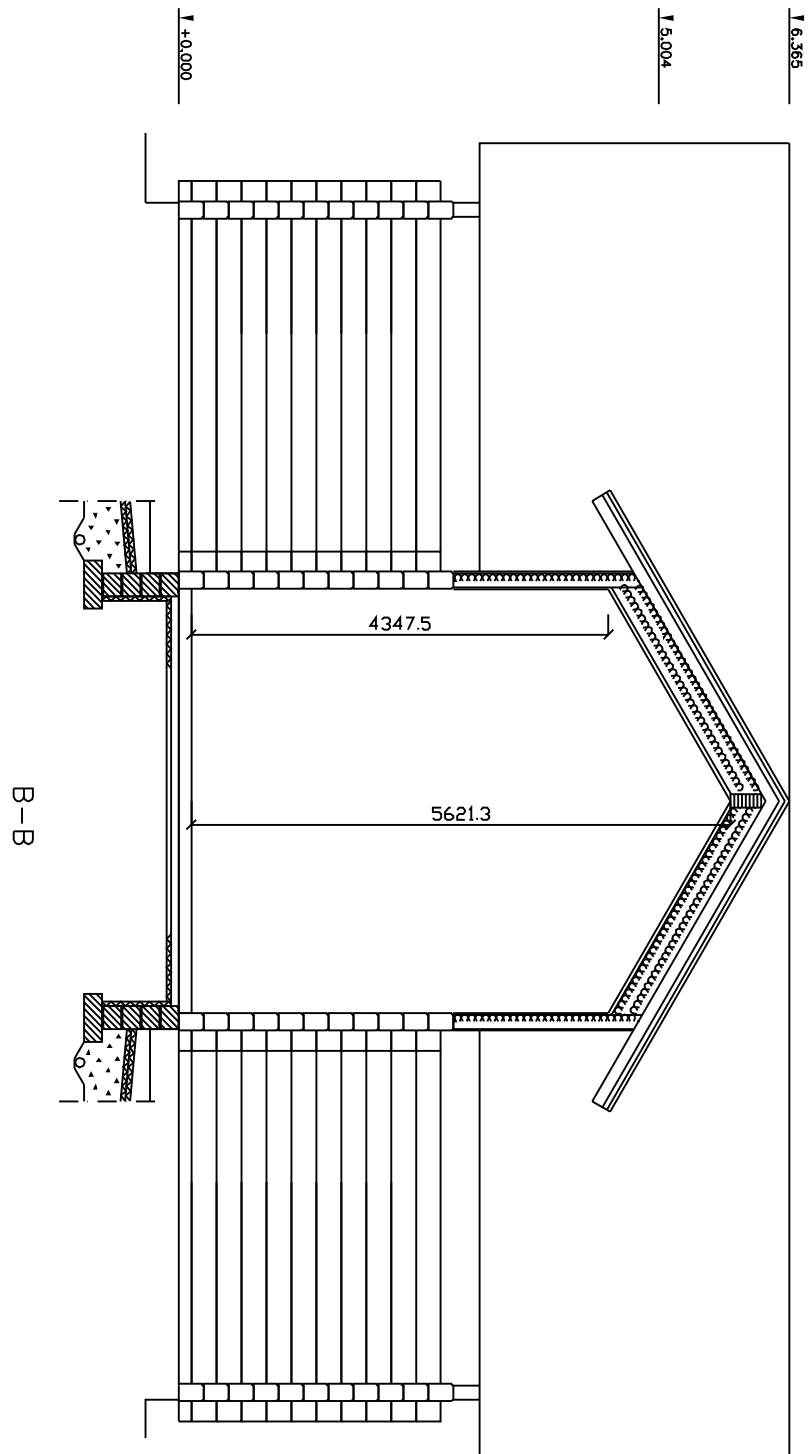

**PEURANKELLO A**  
B-B metszet

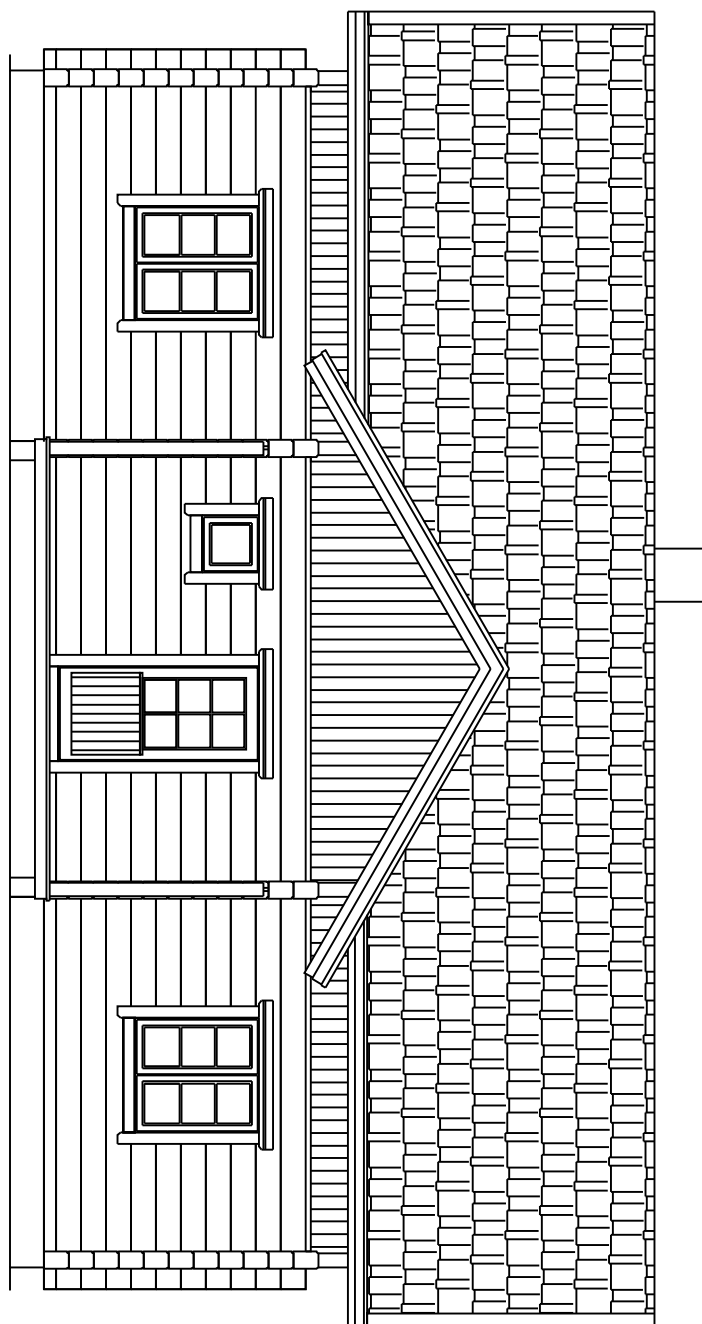

**PEURANKELLO A típus**  
Homlokzati rajz (bejárati oldal)

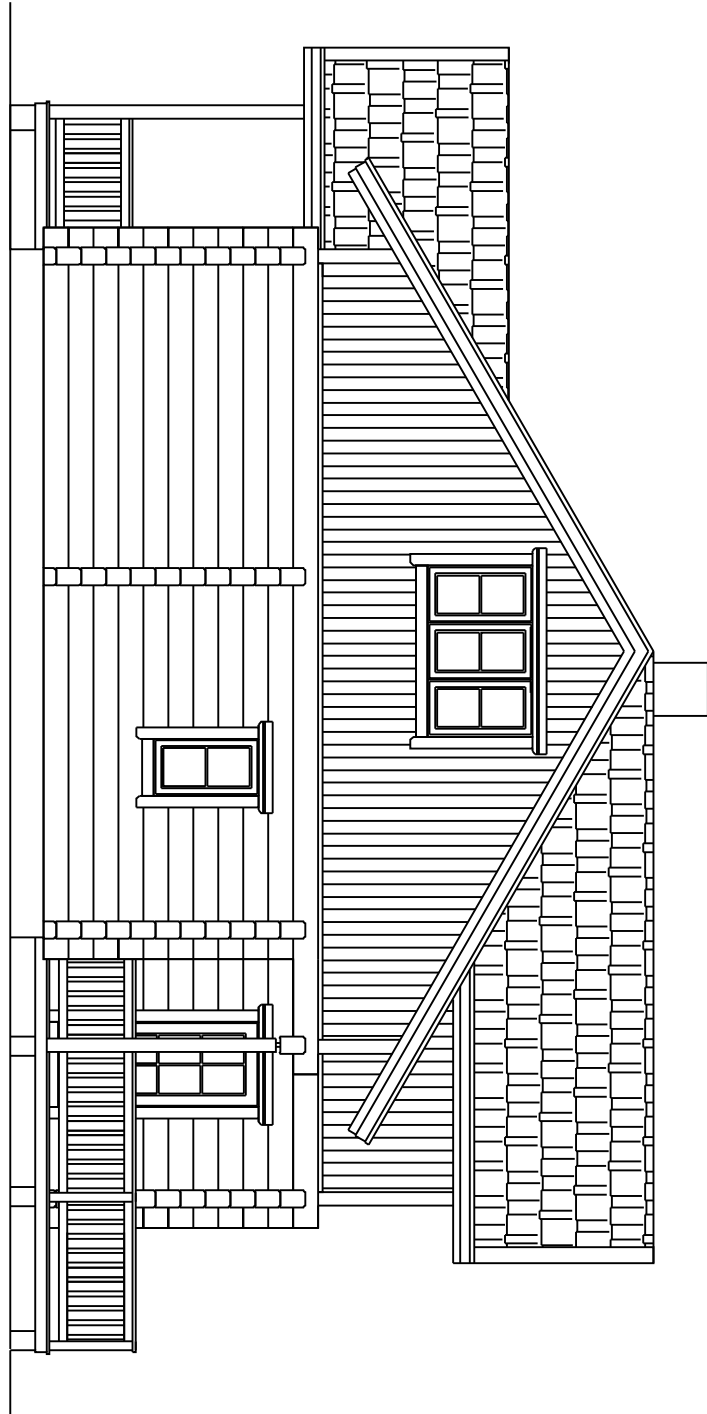

**PEURANKELLO A t pus**  
Homlokzati rajz

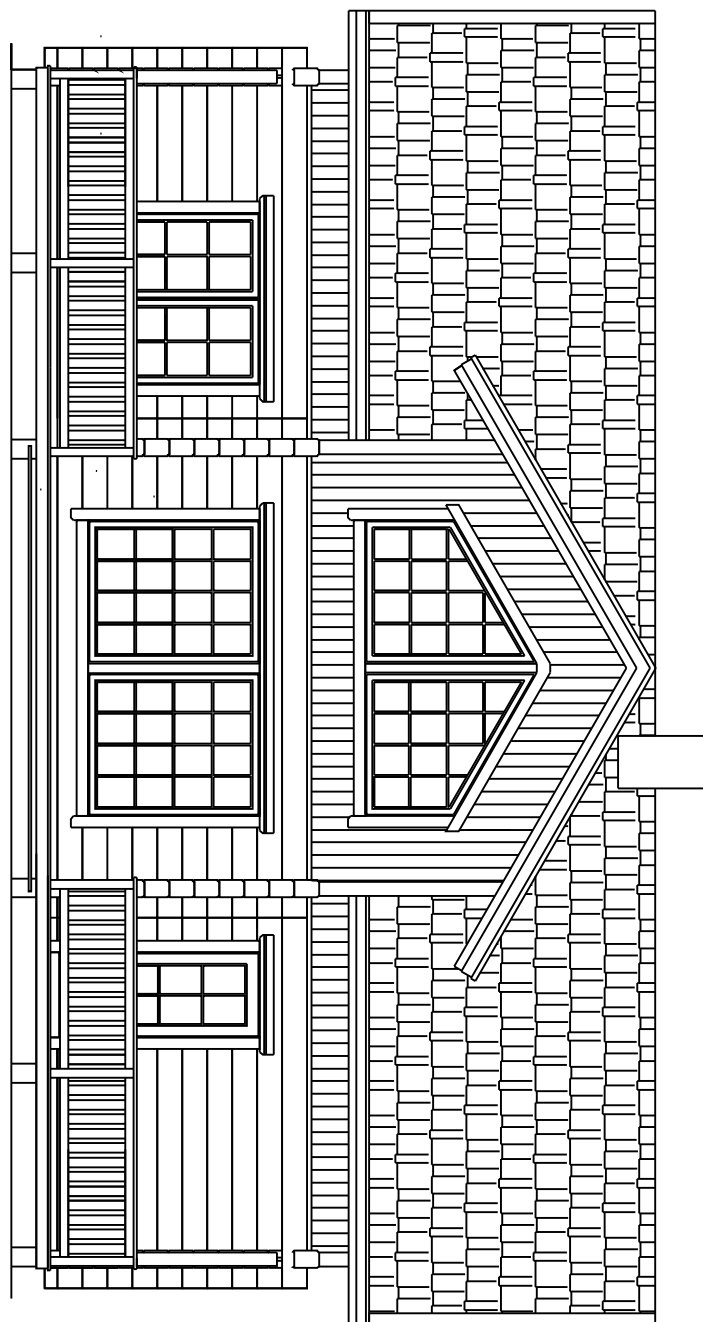

**PEURANKELLO A típus**  
Homlokzati rajz



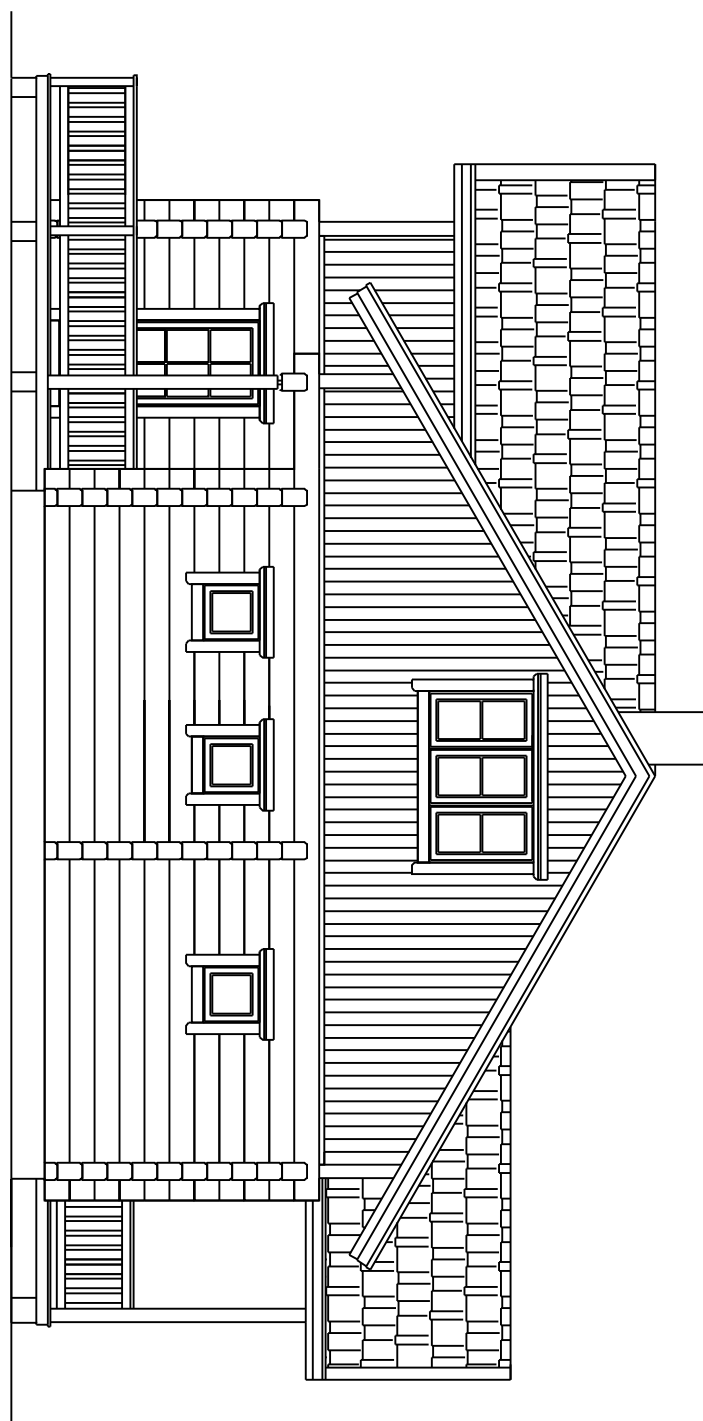

**PEURANKELLO A típus**  
Homlokzati rajz